

REVISIONS			
REV.	DESCRIPTION	DATE	APPROVED

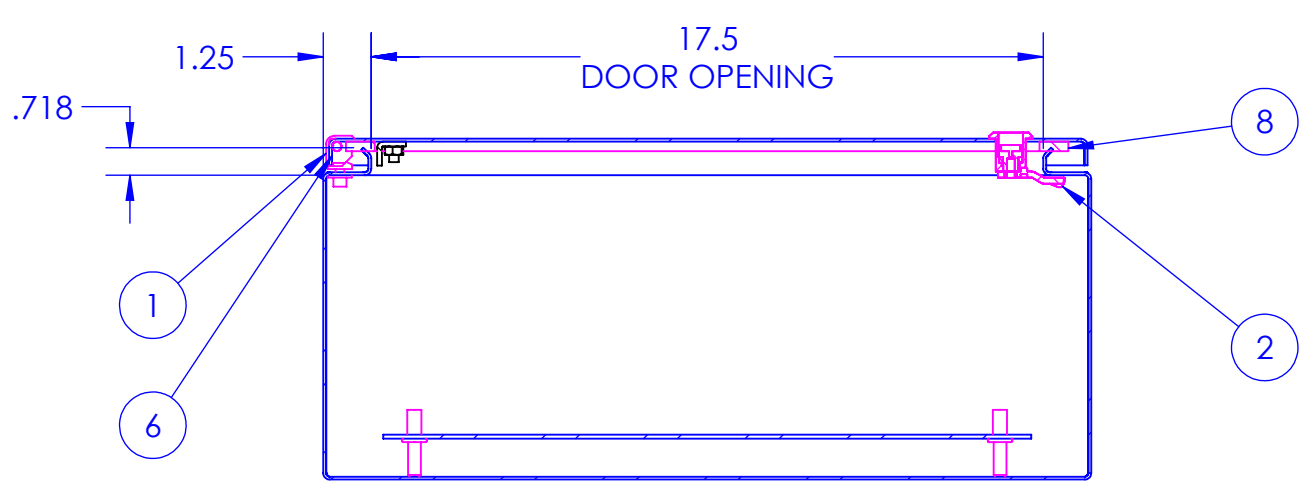

PROPRIETARY AND CONFIDENTIAL		NAME	DATE
THE INFORMATION CONTAINED IN THIS DRAWING IS THE SOLE PROPERTY OF RALSTON METAL PRODUCTS. ANY REPRODUCTION IN PART OR AS A WHOLE WITHOUT THE WRITTEN PERMISSION OF RALSTON METAL PRODUCTS IS PROHIBITED.		DRAWN BY WAYNE SYMNOIT	1/17/2023
UNLESS OTHERWISE SPECIFIED		ISSUED BY WAYNE SYMNOIT	1/17/2023
DIMENSIONS ARE IN INCHES		JOB ORDER NO.	
TOLERANCES:		CUSTOMER DRAWING NO.	
FRACTIONAL ± 1/32"		SHOP DRAWING NUMBER:	V-SS-242008
ANGULAR MATCH 1"		SIZE	PART NAME:
BEND ± 1/32"		C ASSEMBLY	
ONE PLACE DECIMAL ± 0.1"		PART NO.	V-SS-242008
TWO PLACE DECIMAL ± 0.01"		SCALE:	1:5
THREE PLACE DECIMAL ± 0.005"		WEIGHT:	53.617
SEE BOM	(AUTHORIZED SIGNATURE IN RED)	SHEET 1 OF 1	
FINISH:			
SEE BOM	THIRD ANGLE PROJECTION		

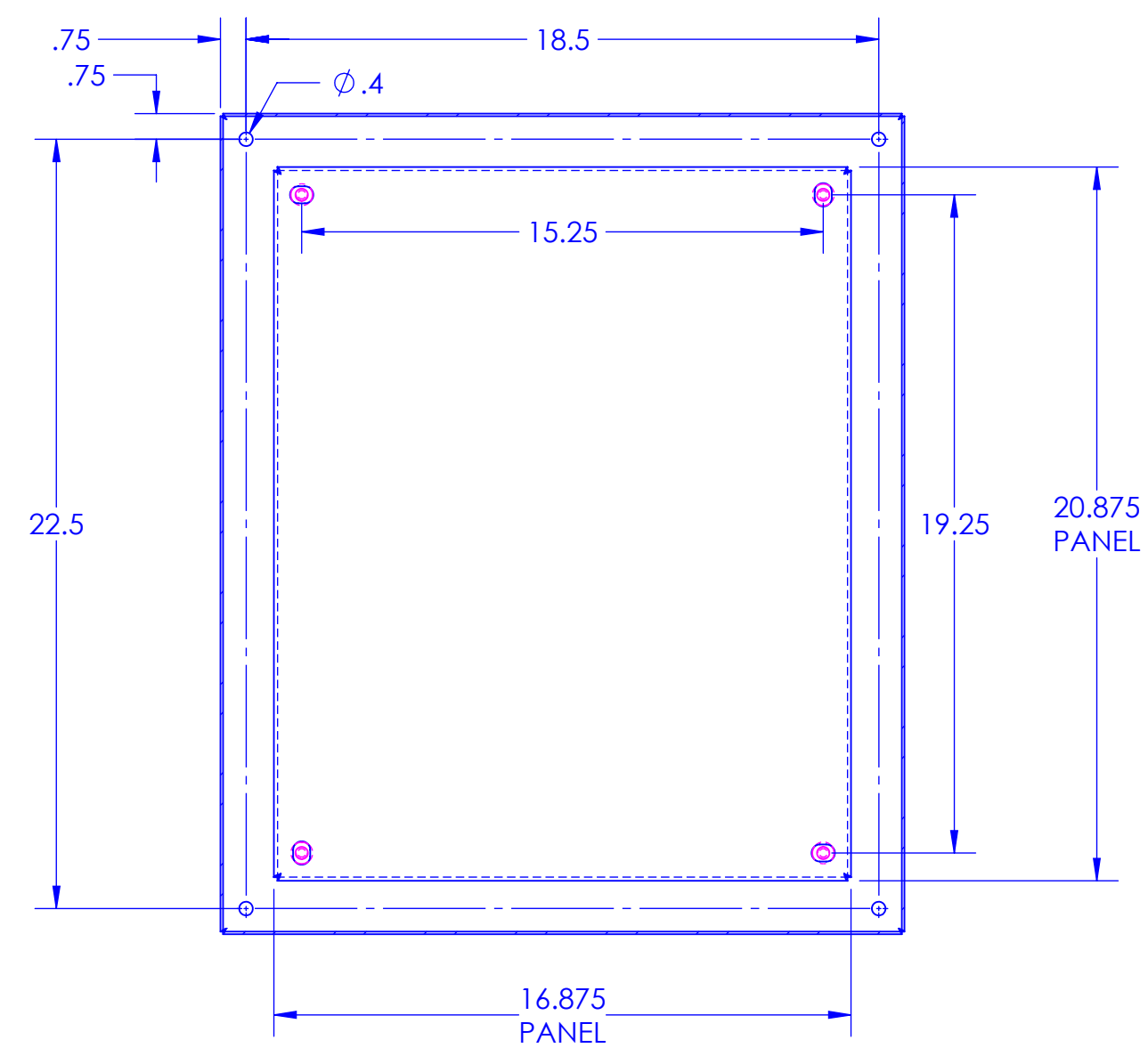
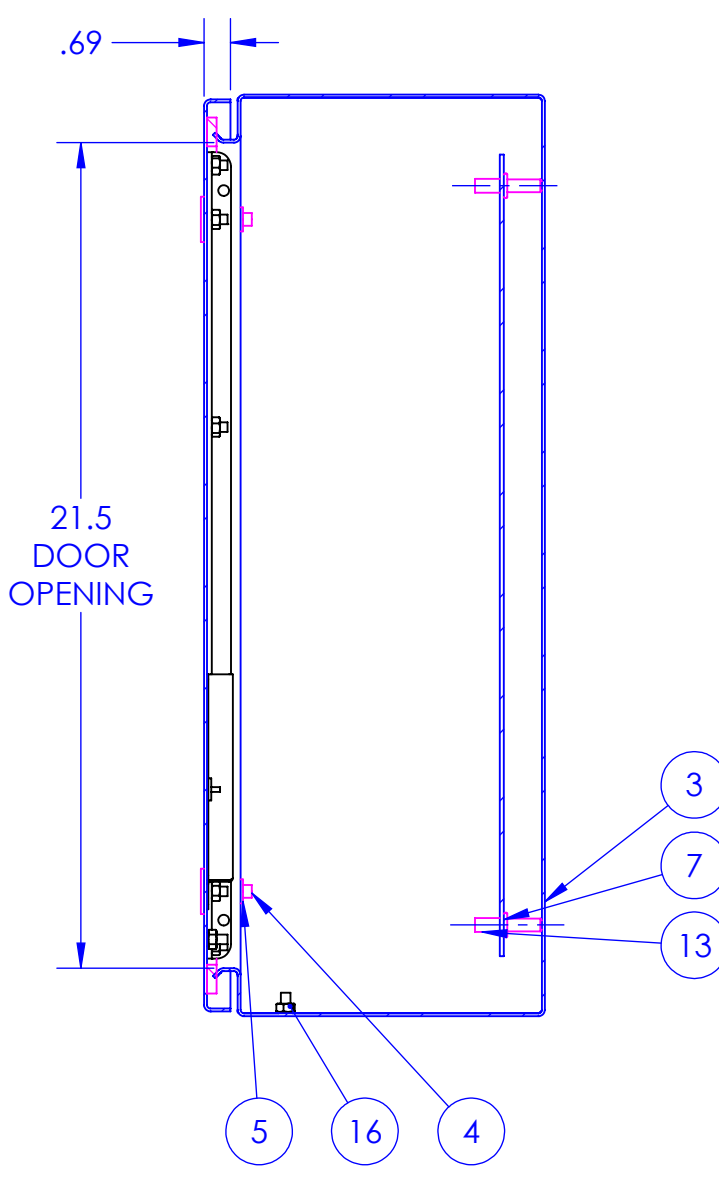
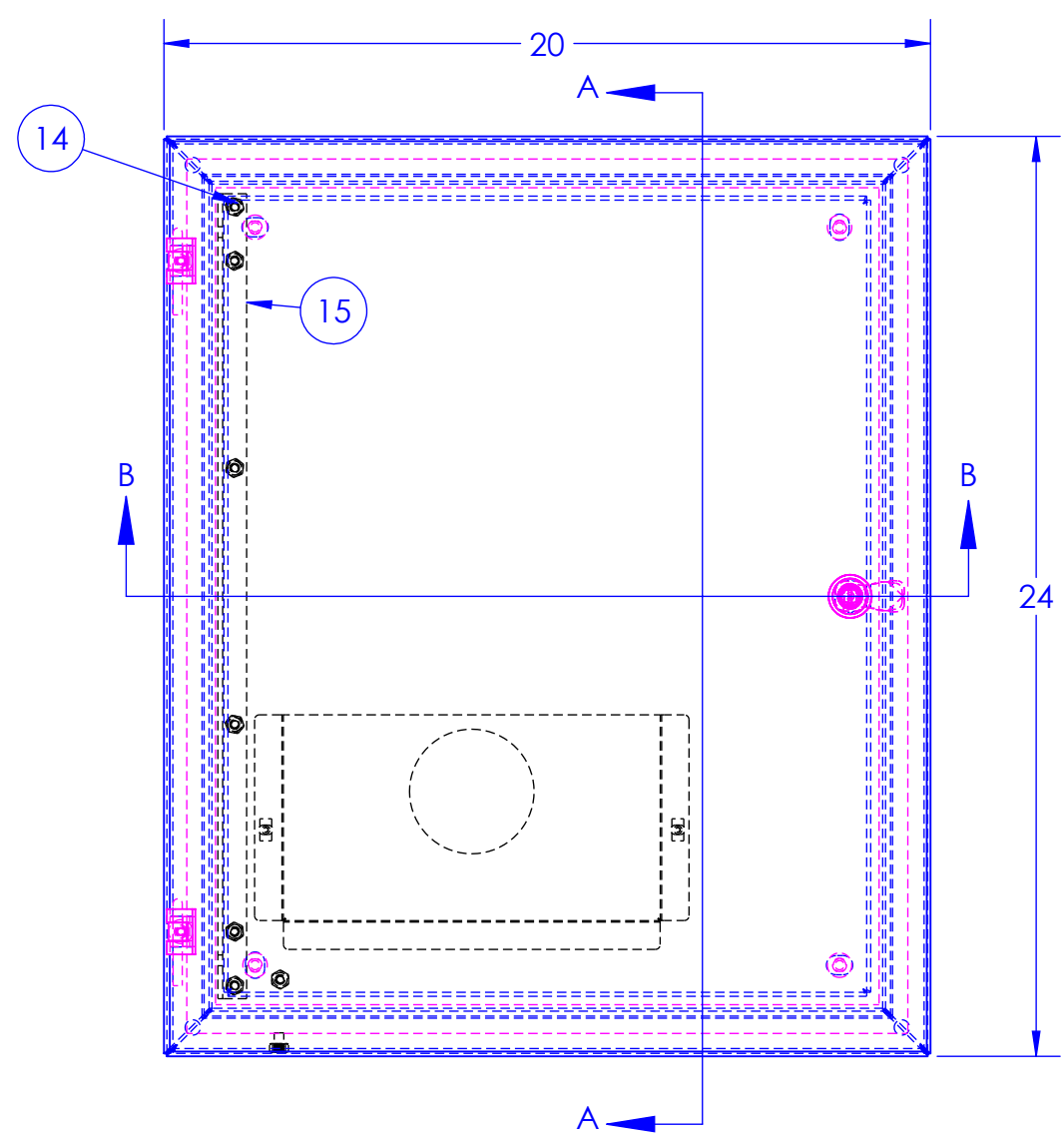
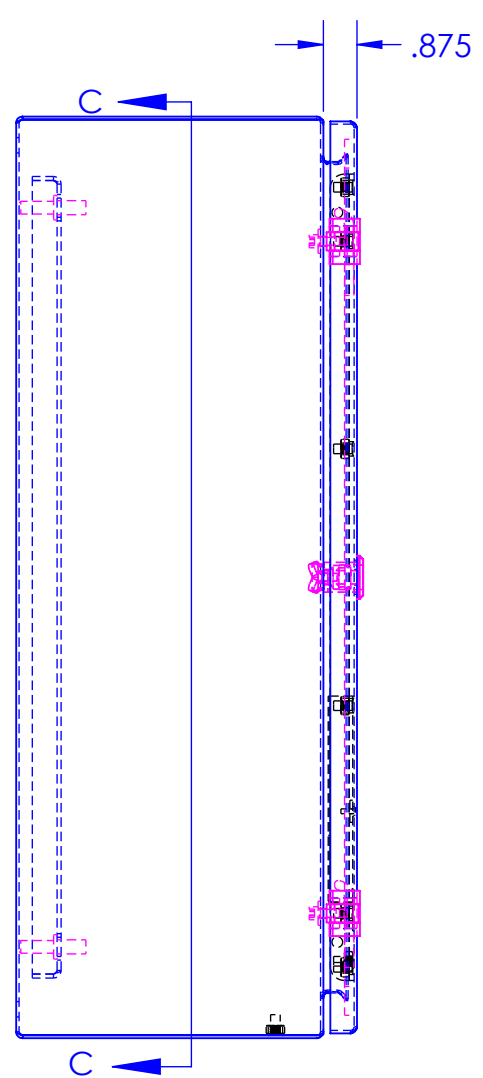
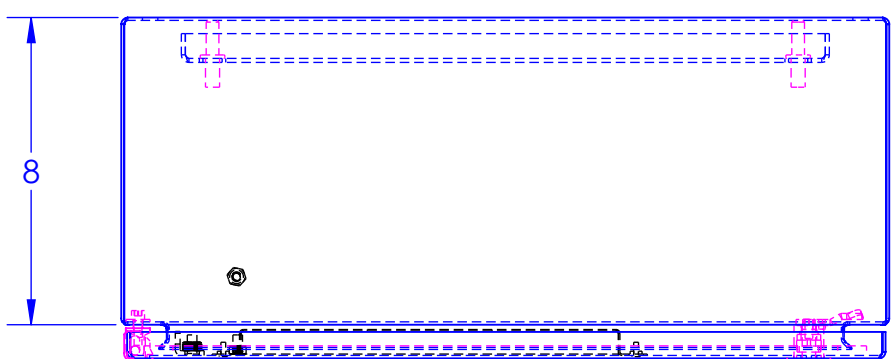
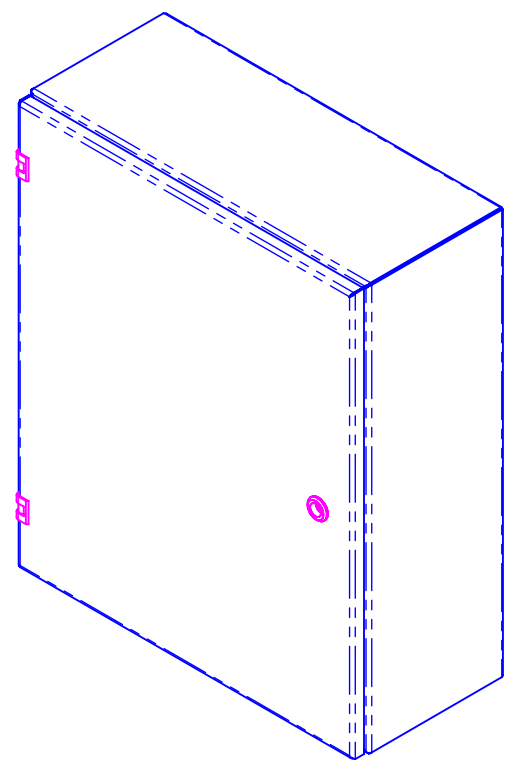

55 WATSON ROAD
QUELUP, ONTARIO N1L 1E2
PHONE: (519) 836-2969
TOLL FREE: 1-800-265-7611
FAX: (519) 836-9793